

# How to Draw **STEVE**

**1**

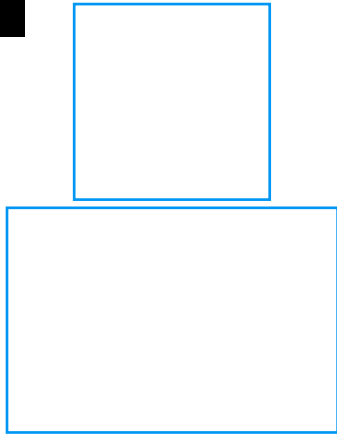

**2**

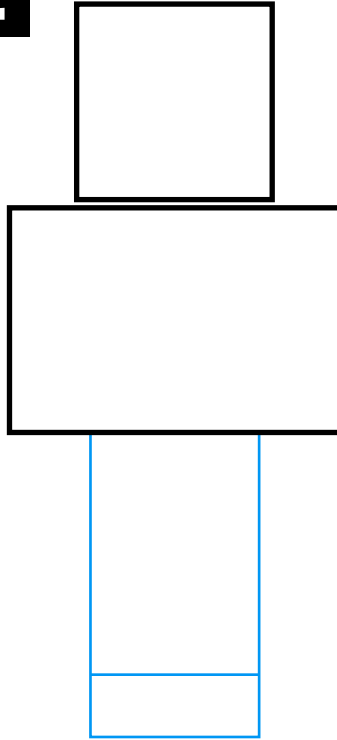

**3**

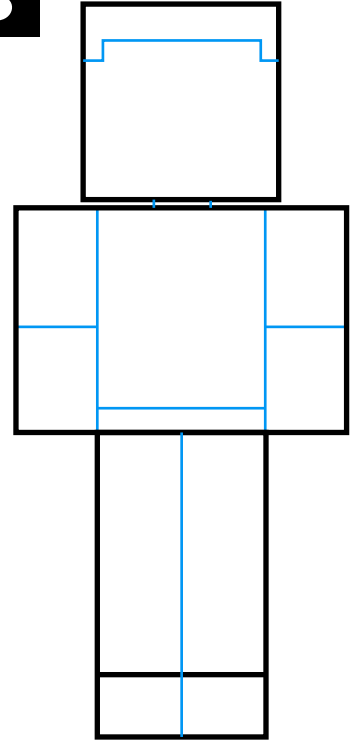

**4**

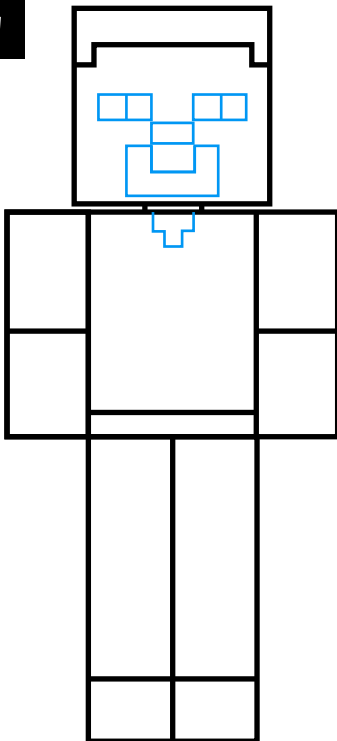

**5**

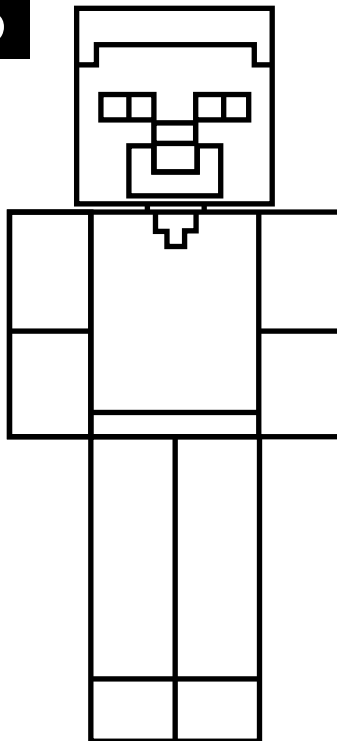

**6**

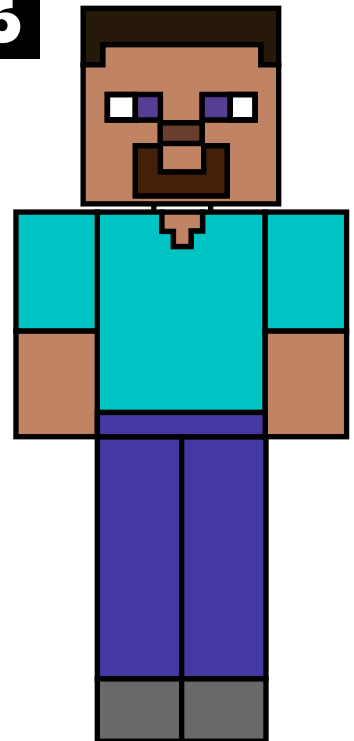

# How to Draw **CREEPER**

**1**

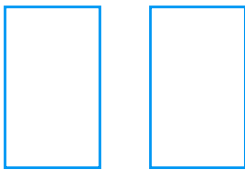

**2**

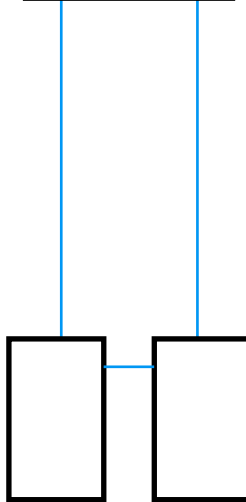
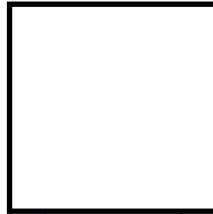

**3**

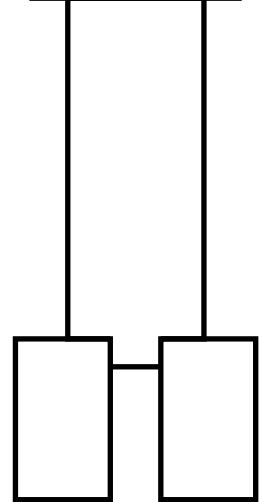
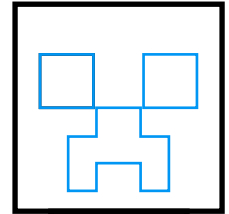

**4**

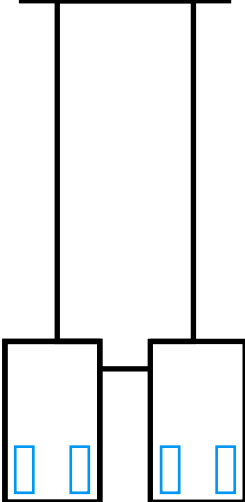
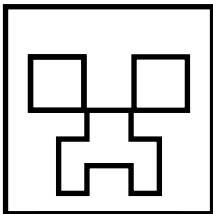

**5**

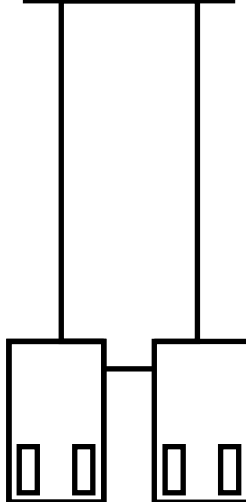
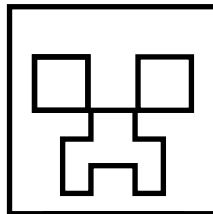

**6**

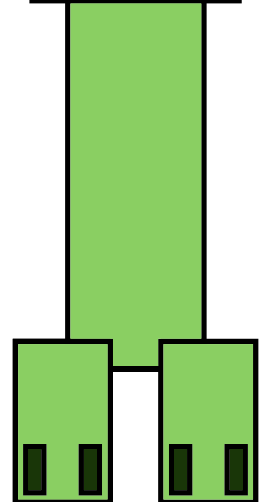
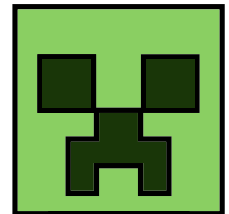

# How to Draw **ENDERMAN**

**1**

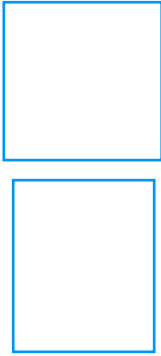

**2**

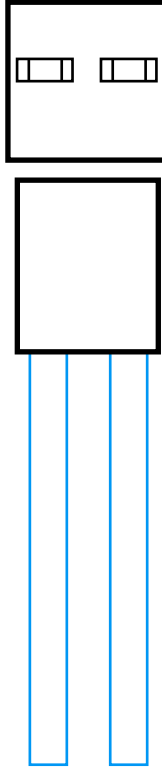

**3**

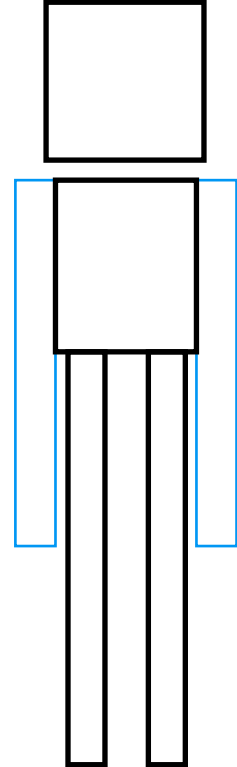

**4**

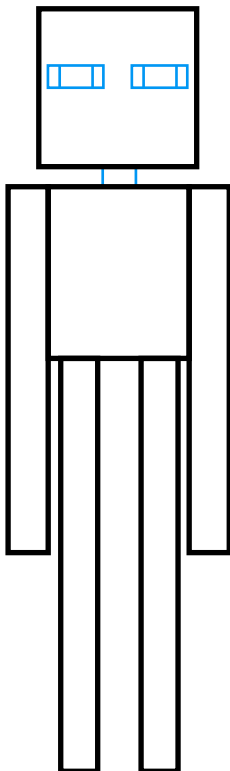

**5**

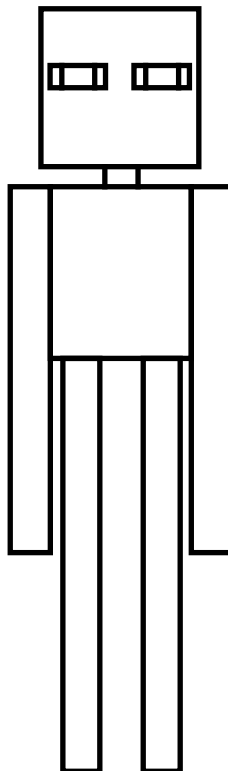

**6**

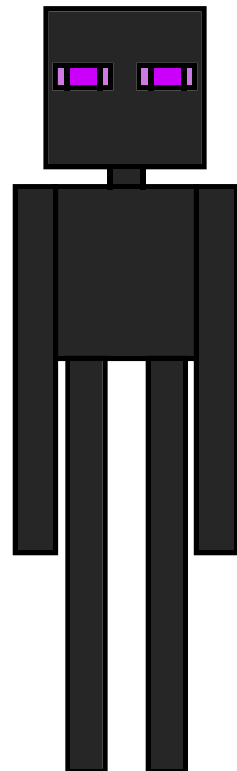

# How to Draw **SKELETON**

**1**



**2**

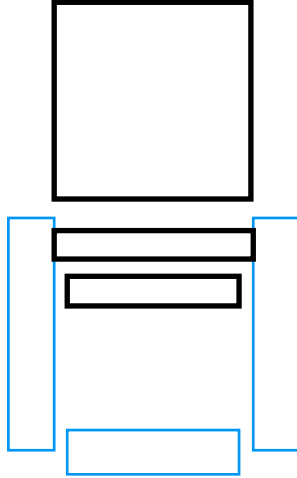

**3**

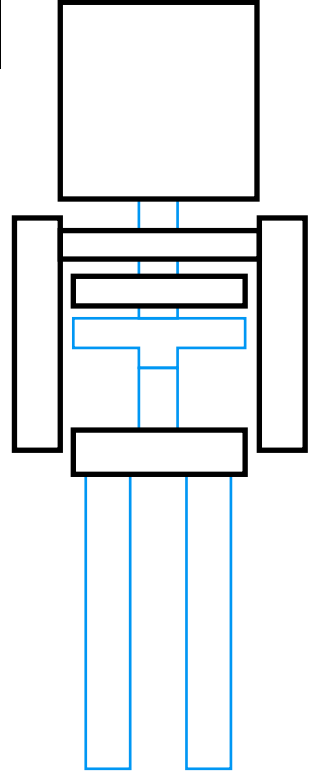

**4**

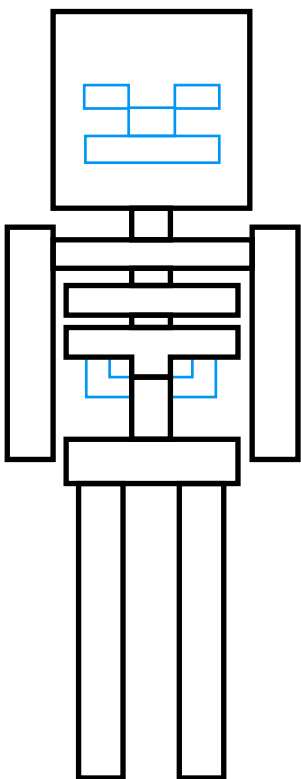

**5**

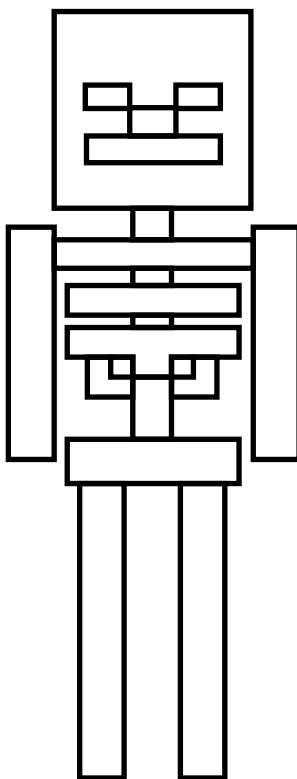

**6**

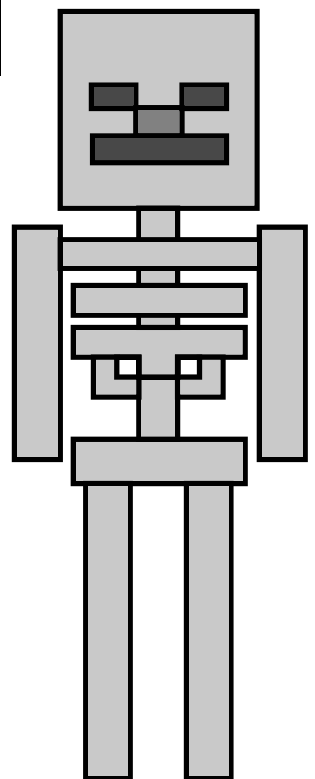

# How to Draw **ALEX**

**1**



**2**

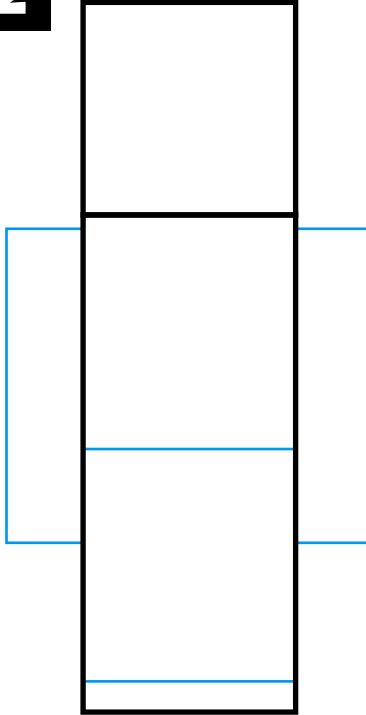

**3**

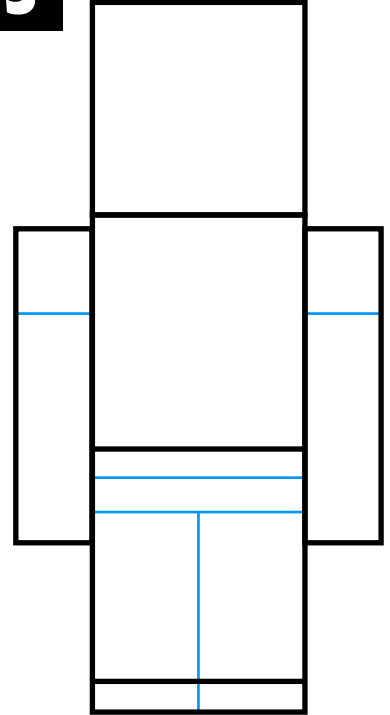

**4**

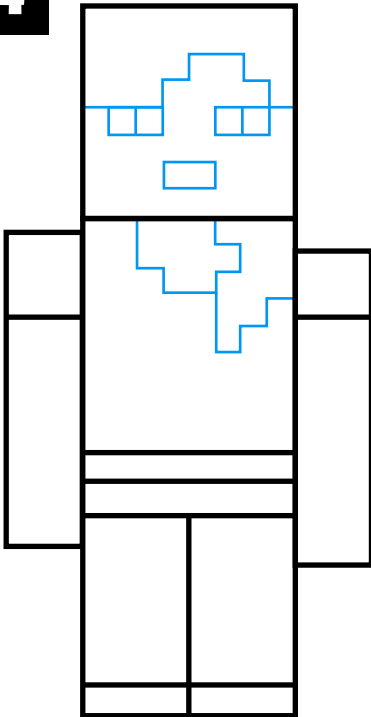

**5**

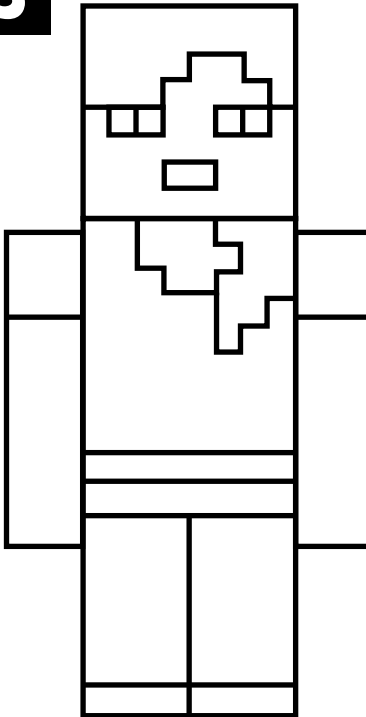

**6**

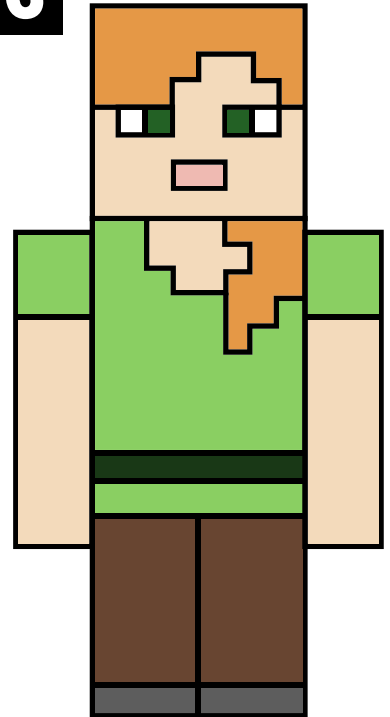



# How to Draw **A PiG**

**1**

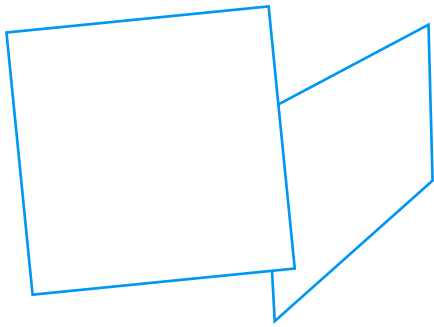

**2**

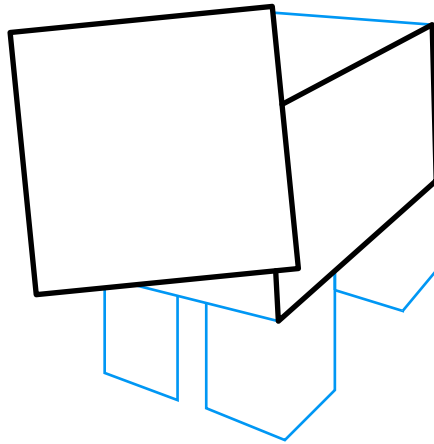

**3**

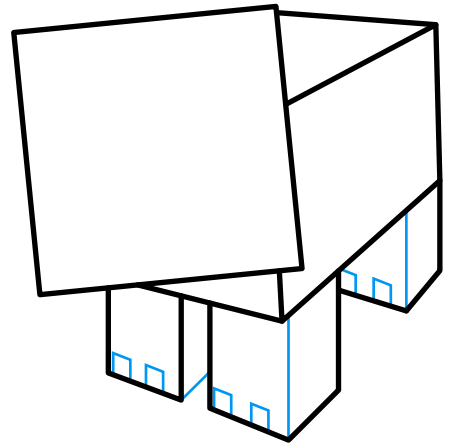

**4**

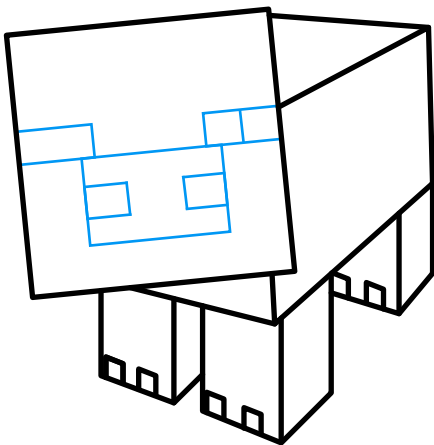

**5**

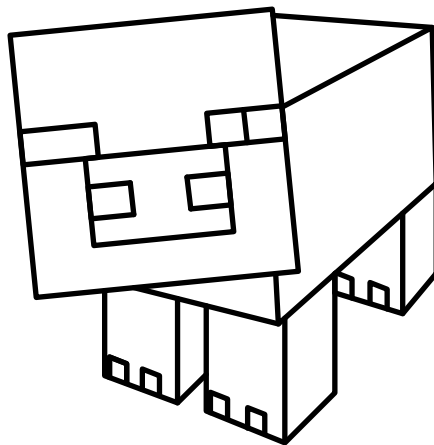

**6**

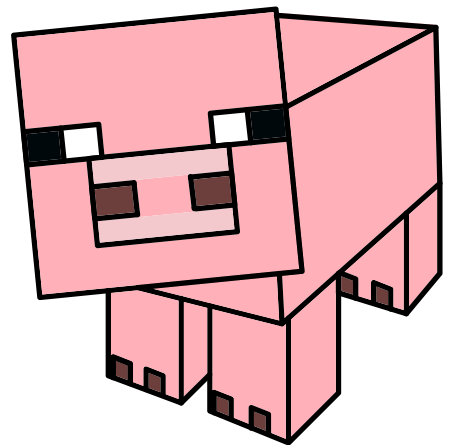

# How to Draw **A SHEEP**

**1**

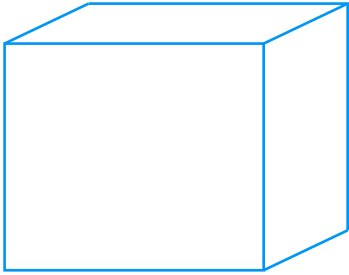

**2**

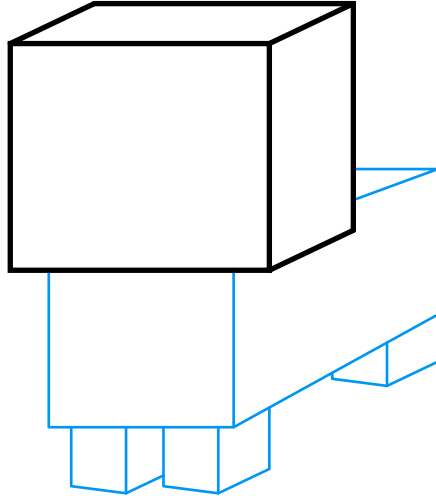

**3**

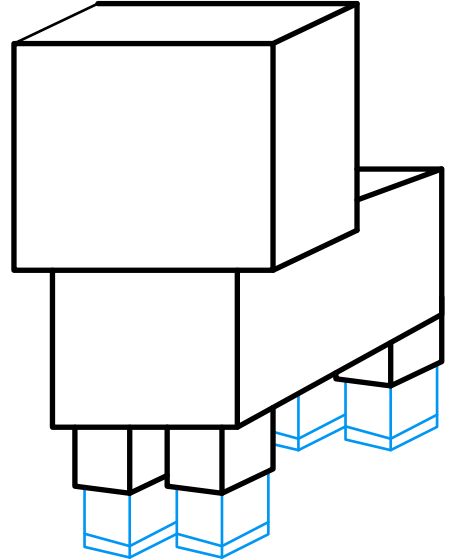

**4**

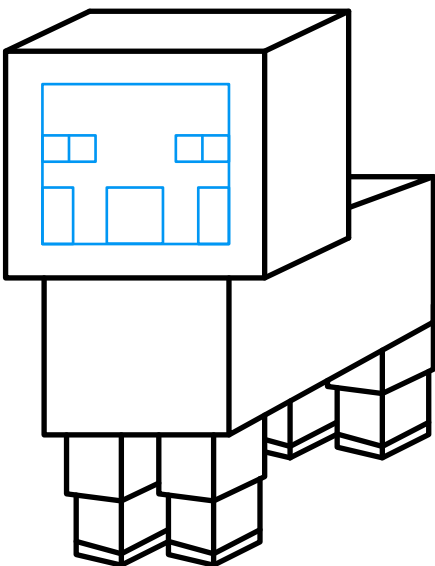

**5**

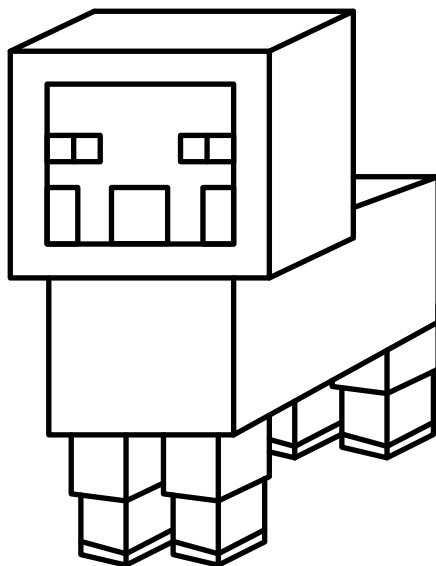

**6**

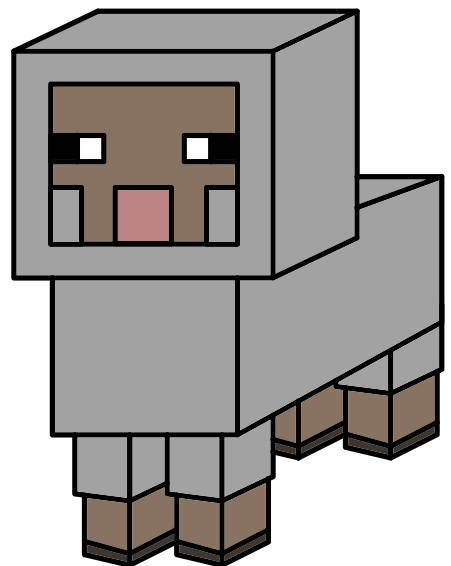



# How to Draw

## **GHA**ST

**1**

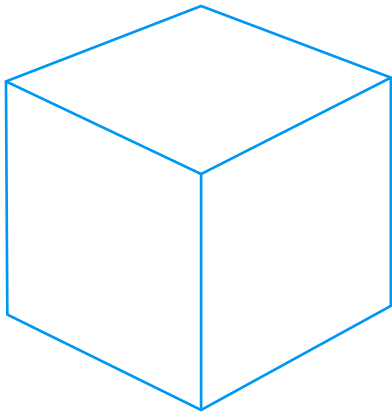

**2**

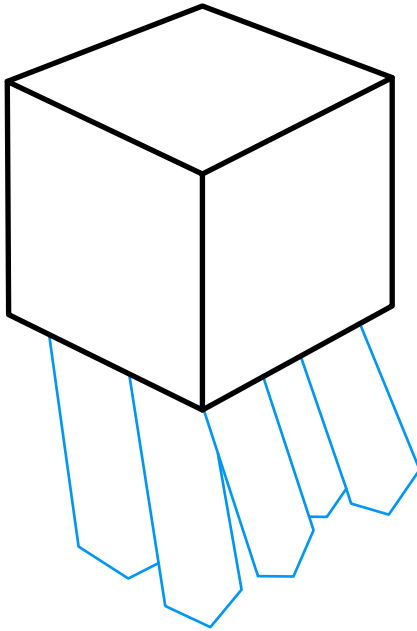

**3**

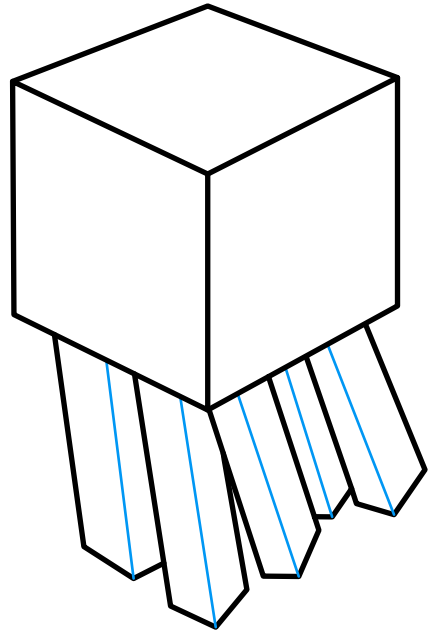

**4**

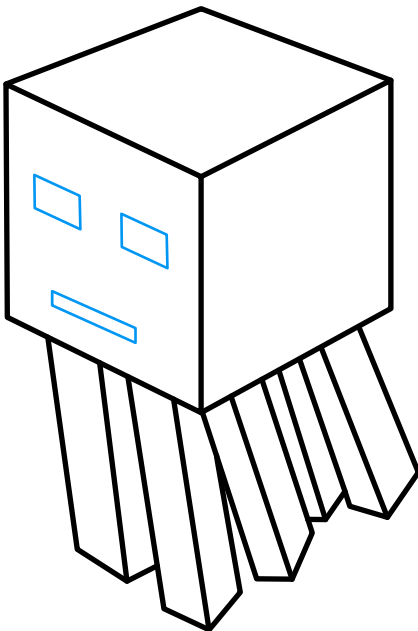

**5**

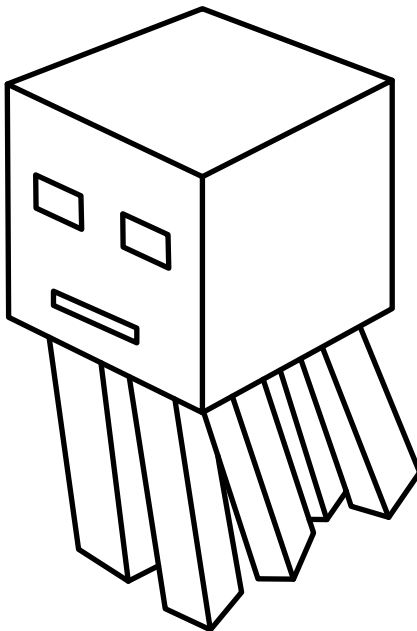

**6**

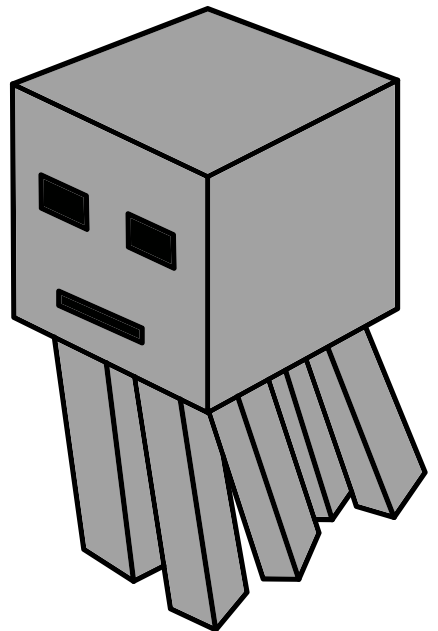

# How to Draw **A CHICKEN**

**1**

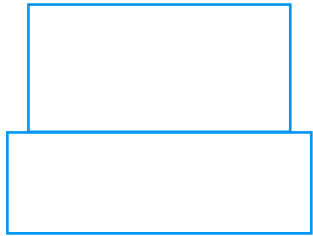

**2**

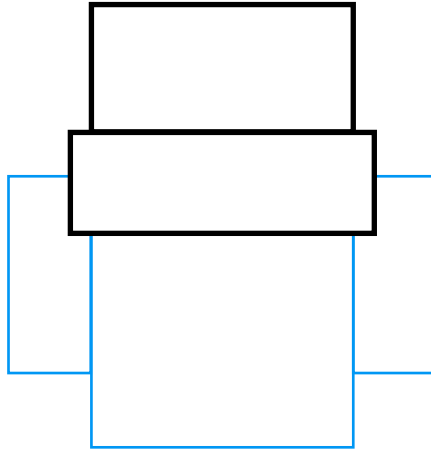

**3**

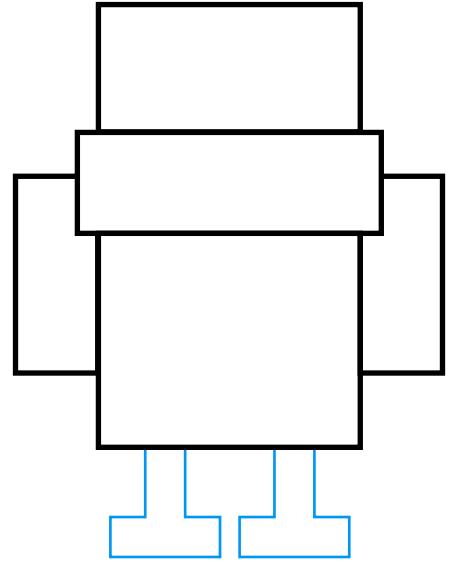

**4**

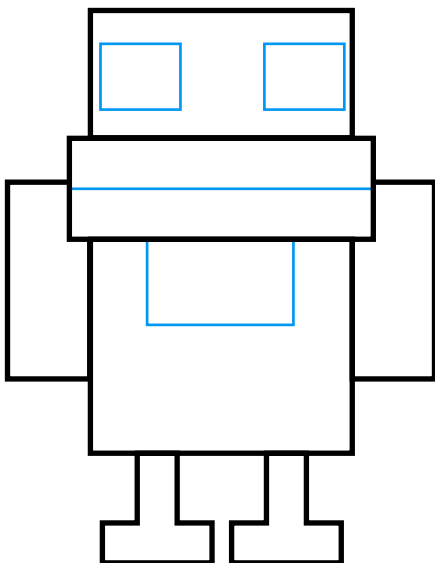

**5**

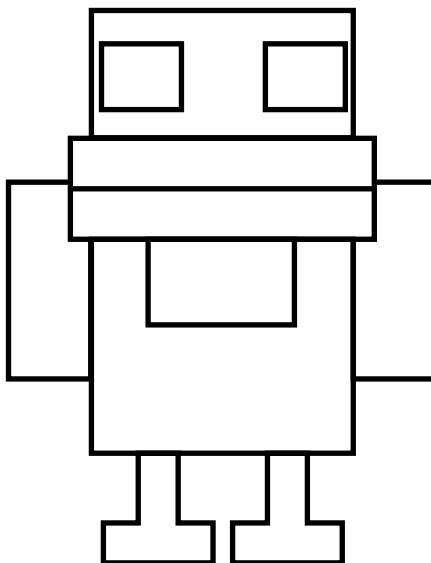

**6**

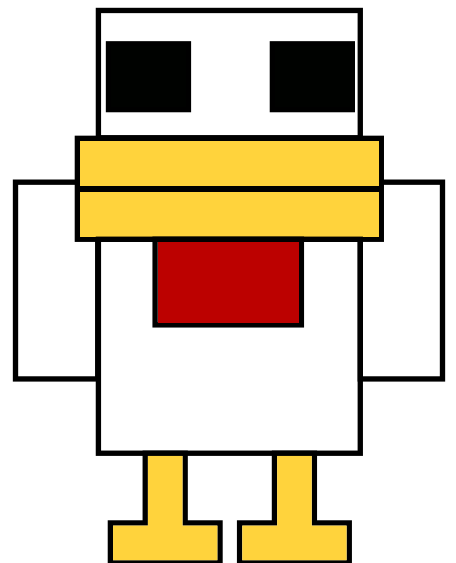

# How to Draw **ZOMBIE**

**1**

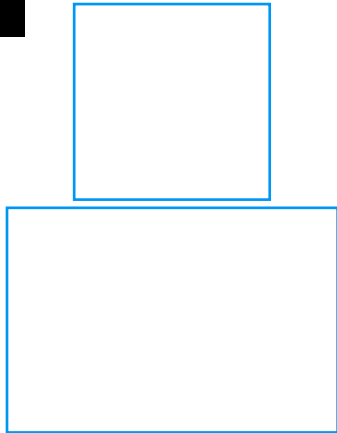

**2**

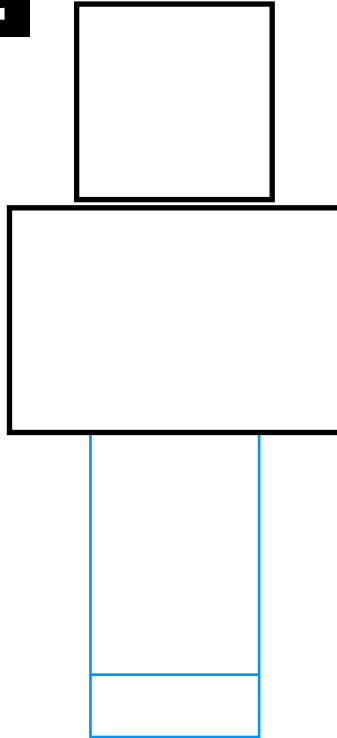

**3**

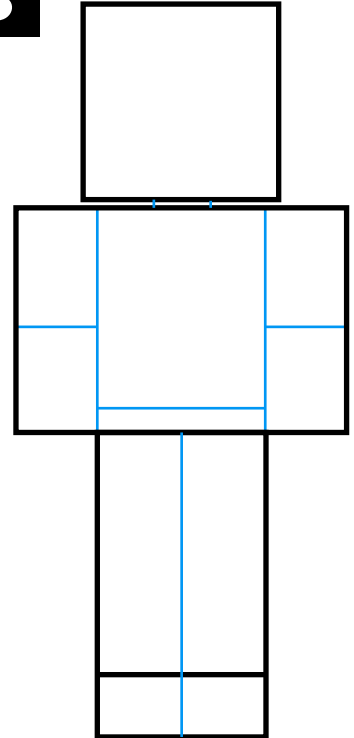

**4**

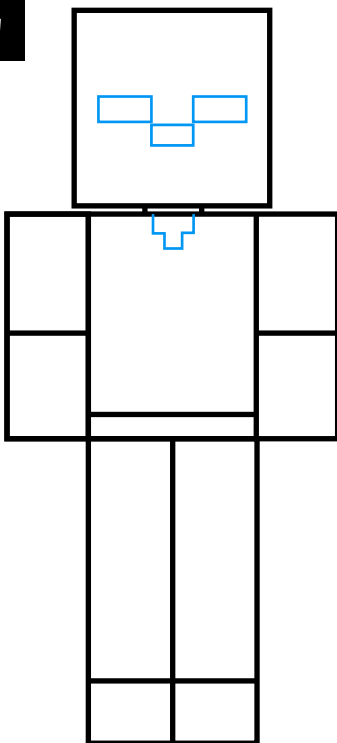

**5**

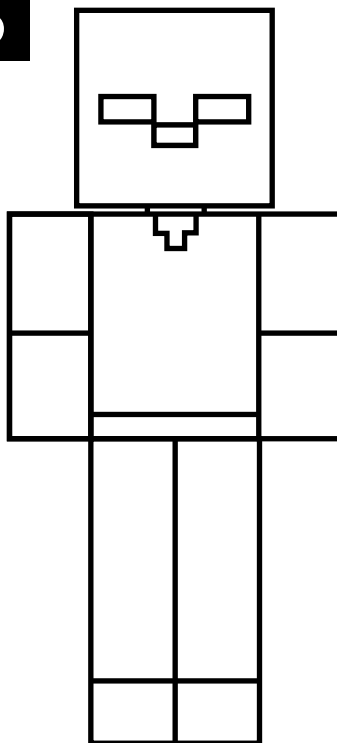

**6**

